

FILE: STP-4.0-04
REV: 03.16.10

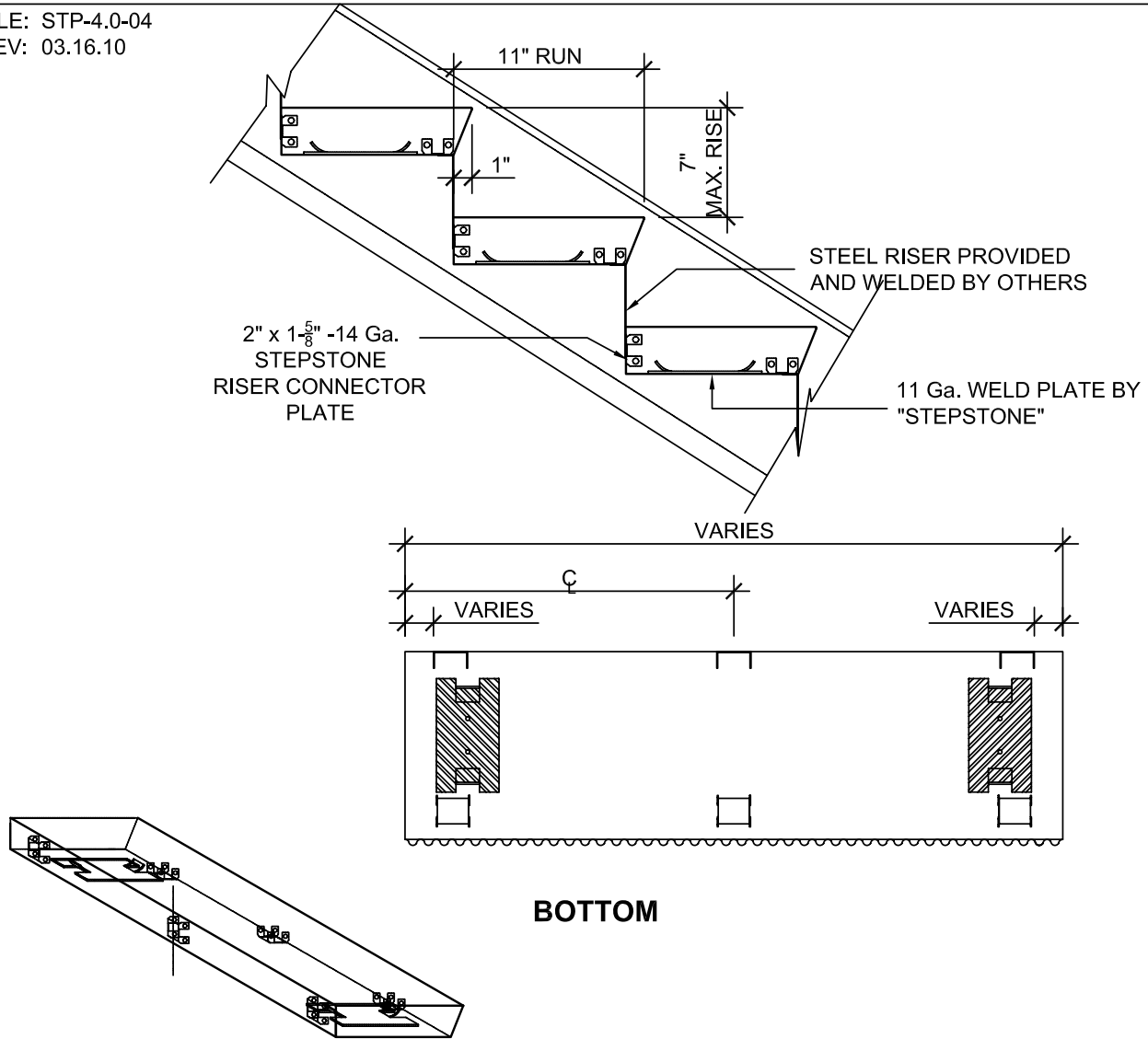

WEDGE PROFILE - WELD ON WITH RISER CONNECTOR PLATES

SCALE: N.T.S.
FILE: STP-4.0-04

PRECAST CONCRETE TREADS, LANDINGS, AND BALCONIES SHOWN ON PLANS SHALL BE FROM THE "STEPTREAD" SYSTEM BY "STEPSTONE, INC." OF GARDENA, CA. FOR STEEL OR WOOD CONSTRUCTION. THE MANUFACTURER IS TO SUPPLY ALL PRECAST CONCRETE PARTS WITH EACH "STEPTREAD" AND FEATURING EITHER CAST IN THREADED INSERTS FOR BOLTING OR AN EMBEDDED BOTTOM WELD PLATE FOR WELDING. ALL REINFORCING AND CONNECTIONS WILL BE ZINC PLATED. ONLY ITEMS NOTED BY "STEPSTONE, INC." SHALL BE FURNISHED BY "STEPSTONE, INC." SUCH ITEMS SHALL BE INSTALLED BY OTHERS.